

Project:



Lift Station

Assembly Instructions

Table of contents

1.	General information.....	3
1.1	System manufacturer.....	3
1.2	Version.....	3
2.	Safety.....	4
2.1	Intended use.....	4
2.2	Safety components not installed.....	4
2.3	Installed safety components.....	4
2.4	Safety instructions for transportation.....	4
3.	Technical data.....	5
3.1	Mechanical.....	5
3.2	Conveyed material.....	5
3.3	Ambient conditions.....	5
4.1	Base frame.....	6
4.	Mechanical design.....	6
4.2	Linear motion unit.....	7
4.3	Carriage.....	8
5.	Maintenance, servicing and cleaning.....	9
6.	Maintenance, repair and troubleshooting.....	10
6.1	Securing the carriage.....	10
6.2	Linear motion unit.....	11
7.	Components used.....	14
7.1	Zone sensor for powered roller conveyor.....	14
7.2	Light curtain.....	14
7.3	Reflector.....	14
7.4	Inductive sensor.....	15
7.5	Safety switch on the maintenance door (optional).....	15
7.6	Motor with absolute encoder.....	16
7.7	Converter with profinet card.....	17
8.	EU Declaration of Incorporation.....	18

1. General information

1.1 System manufacturer

Robotunits GmbH
Dr. Walter Zumtobel Str. 2
Tel. +43 5572 22000 200
Fax +43 5572 22000 9200
www.robotunits.com

1.2 Version

Version	Type	Date
01	New document	4/28/2022

2. Safety

2.1 Intended use

The lift station complements the Robotunits roller conveyor system and enables the vertical transport of conveyed material. For technical data, see chapter 3.

Since the lift station is supplied without a control system, it is a "partly complete machine" as described in the Machinery Directive 2006/42/EC.

See appendix for Declaration of Incorporation.

The lift station is executed without safety devices upon agreement with the customer.

Reasons:

- **the lift station is located in a closed off area**
- **the customer installs the safety guards himself**
- **the lift station is not accessible for people**

2.2 Safety components not installed

- Maintenance door
- Tunnel in the infeed/outfeed area
- Fixed guards (contact protection, accident protection)
- Safety switches with safety monitoring Pld, SIL 2

2.3 Installed safety components

- Load holding device for maintenance work

2.4 Safety instructions for transportation

- Secure against tipping over
- Do not store outdoors
- Consider the center of gravity when lifting
- Standing under the load is prohibited
- Use a suitable means of transport
- Load application points see chapter 4.1
- Securing the carriage see chapter 6.1

3. Technical data

3.1 Mechanical

- Stroke: mm
- Infeed height: mm
- Weight of conveyed material: kg (max. 50 kg)
- Weight of lift station: max. 500 kg (depending on version)
- Speed: max. 1m/s
- Acceleration / Deceleration: 0.7 m/s²
- Positioning accuracy: ± 1mm
- Torque: max. 60 Nm
- Airborne noise emission: 75 dBA

3.2 Conveyed material

- Dimensions: mm
- Material:

3.3 Ambient conditions

- Ambient temperature: + 2°C to + 40°C (avoid thermal shocks)
- Humidity: < 90 %
- Vibrations: < 0,5 g

4. Mechanical design

4.1 Base frame

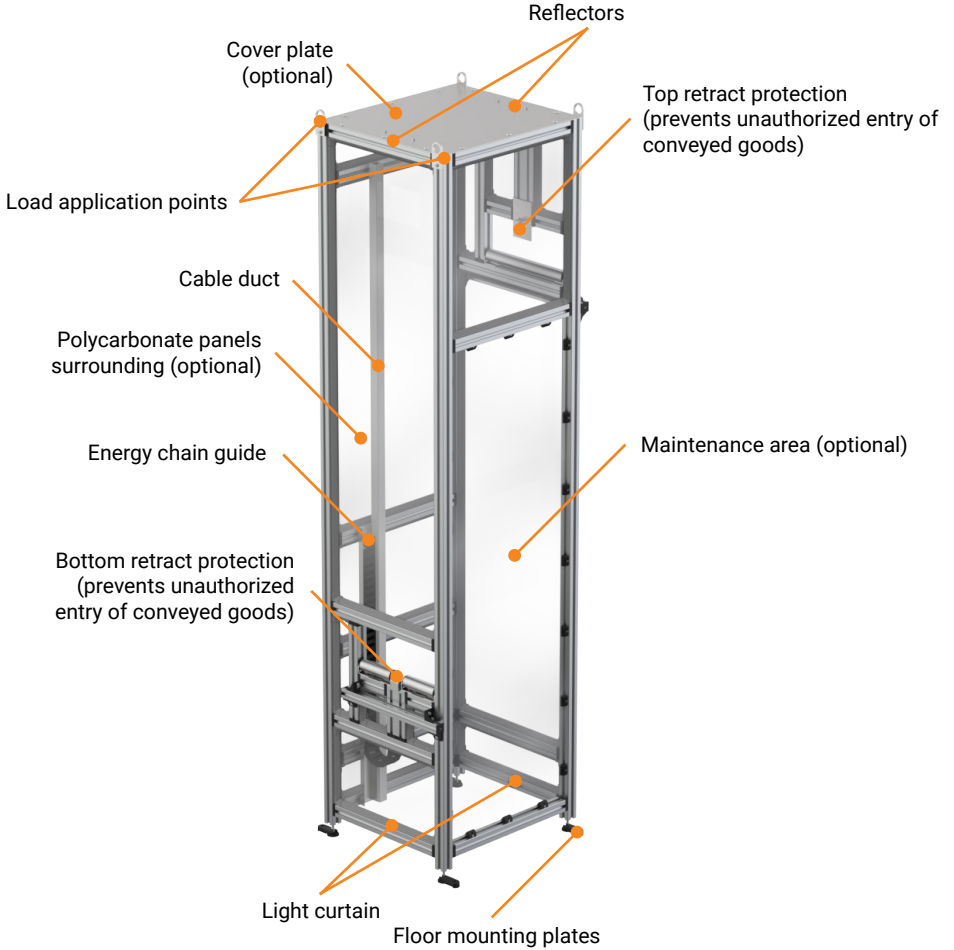

4.2 Linear motion unit

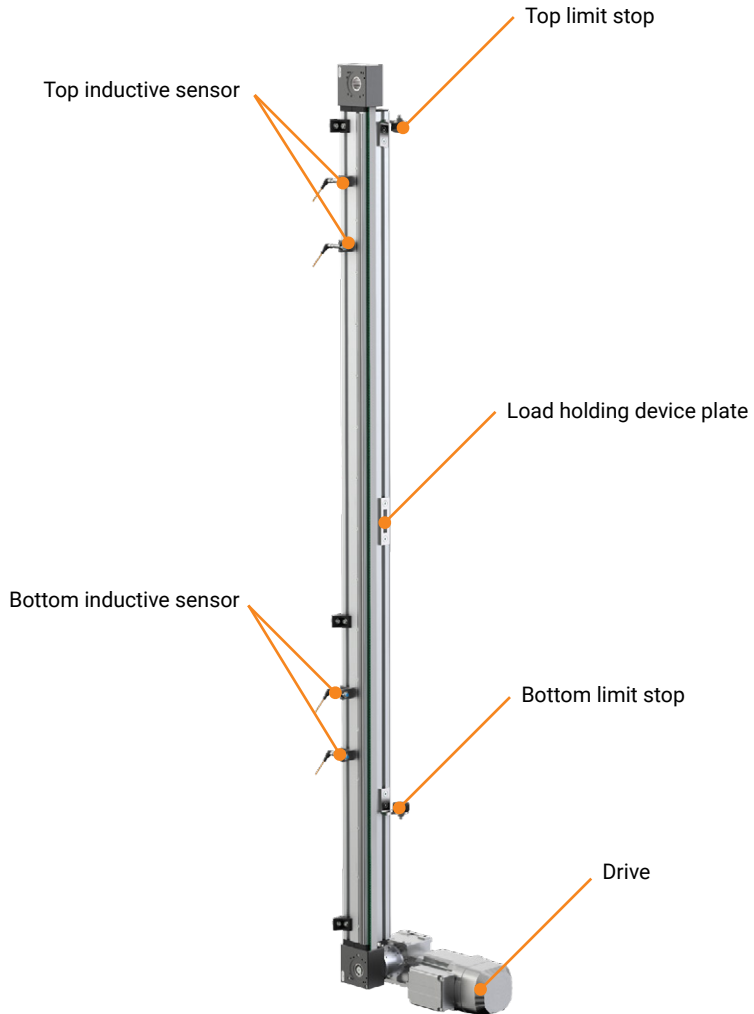

The load is held indirectly via the motor brake only. In the event of a brake failure, the carriage will fall down in the lift station. A brake proof test is not provided.

For maintenance work, the carriage must be moved to a safe position via the control system.

Securing the carriage: see chapter 6.1.

4.3 Carriage

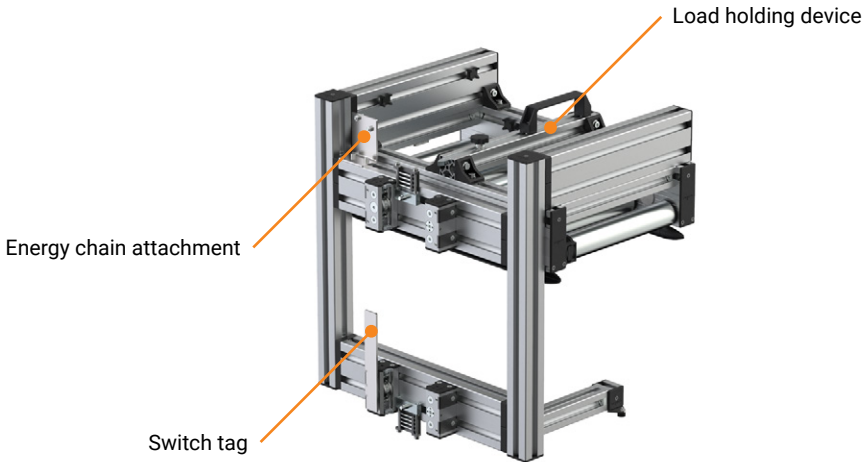
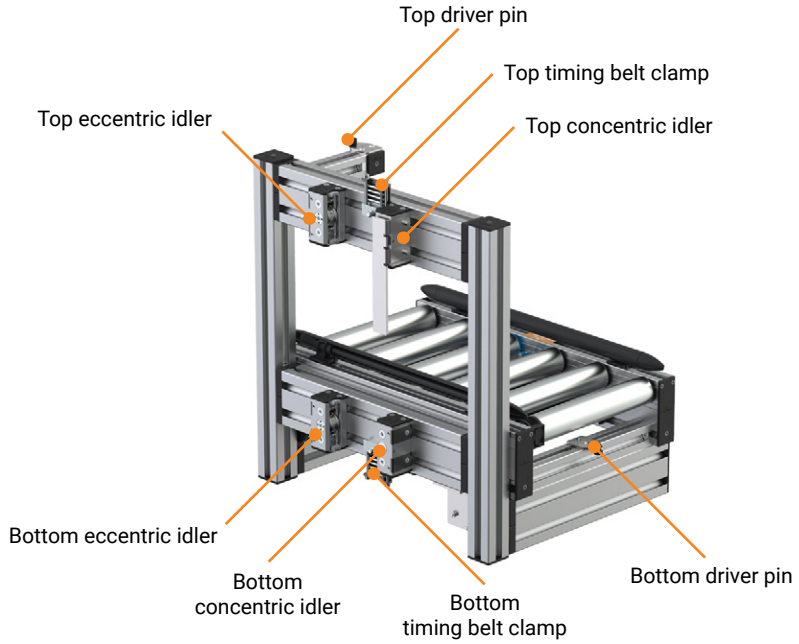

5. Maintenance, servicing and cleaning

Proper maintenance of the machine is essential for reliable operation and a long service life.

Work to be performed by the operating personnel:



- Machine shutdown
- Clean with dry or slightly damp, soft cloths (Polycarbonate panels are susceptible to scratches)
- Use a vacuum cleaner to remove larger quantities of contamination.
- Clean sensors, if necessary
- Check tension of toothed belt
- Visual inspection for damage; if necessary, request repair from the plant maintenance department

6. Maintenance, repair and troubleshooting

The spare parts list can be found in the appendix.

Work to be carried out by trained specialists from the plant maintenance department:

6.1 Securing the carriage

 DANGER	
 	<p>Hazard due to lifted load</p> <p>Secure the carriage with the load holding device, procedure:</p> <ul style="list-style-type: none">• Move lift station to maintenance position• Loosen the star handle• Push the load holding device forward as far as it will go• Tighten the star handle

Star handle

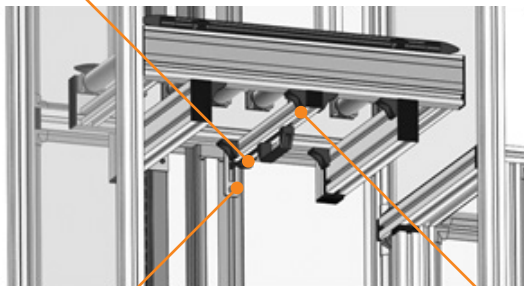

Safety lock plate

Safety lock

If moving the carriage to the maintenance position is not possible for any reason, e.g. failure of the control system, the carriage must be secured in an alternative way (e.g. suspended or placed underneath).

6.2 Linear motion unit

Maintenance schedule

Maintenance point / Activity	Maintenance interval	Info
Belt tension	after 1,000 operating cycles	once
Slider play	after 1,000 operating cycles	once
Clean linear guide	every 600 h	
Lubricate wiper unit	every 600 h	Slideway lubricant according to DIN CGLP ISO VG68 (e.g. Mobil Vactra No. 2)
Check belt condition	every 600 h	visually
Check machine for loose screws	every 2,000 h	

Belt replacement



1. Loosen belt tensioner unit



2. Remove belt tensioner

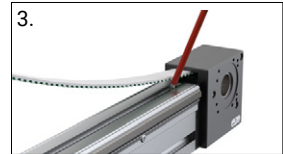

3. Loosen the fastening screws of one of the pulleys



4. Pull out and replace belt

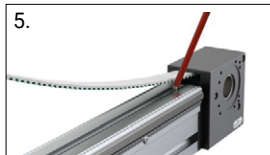

5. Reattach the pulley



6. Mount belt tensioner, insert screws and retighten belt tensioner unit

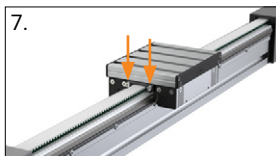

7. Tighten both screws of the belt tensioner unit with the same torque and tension the belt to 32Hz (reference length 1 m).

Adjusting the carriage

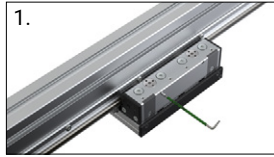

1. Unscrew the set screw in order to loosen the eccentric nut.

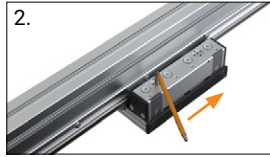

2. Without applying force, move the eccentric roller to rest against the guiderail until the carriage no longer has any play.



3. Fasten the eccentric cam by tightening the lock nut with the corresponding wrench

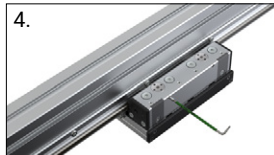

4. Tighten the set screw in order to fix the eccentric nut.

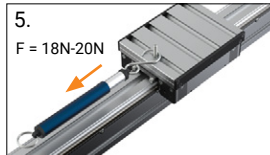

5. Check smooth running of the carriage. Adjust without belt mounted on the slide!

6.3 Powered roller conveyor

Maintenance point / Activity	Maintenance interval	Info
Electrical installations	2 times per year	visual inspection for damages and check for firm attachment
Poly-V drive belts	every 3 months	visual inspection for damage (such as cracks or porosity)
Poly-V protection guard	every 3 months	check for firm attachment
Screw connections after initial commissioning	1 month after initial commissioning	check for tight fit
Screw connections	once a year	check for tight fit
Sensor	as required	remove any dirt that may be present

Replacing the Poly-V belt

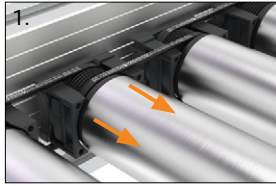

1. Remove protective elements



2. Remove the cover profiles from both sides

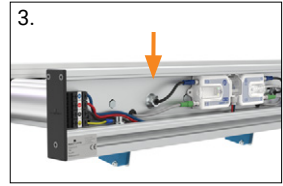

3. Loosen the hexagonal nut and remove the torque support if necessary (only for motor rollers)

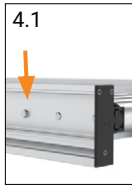

4.1 Press the spring axis to the stop in the direction of the rollers

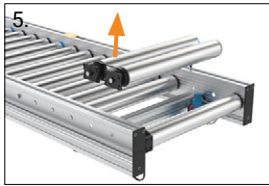
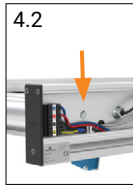

5. Lift the rollers out of the mount

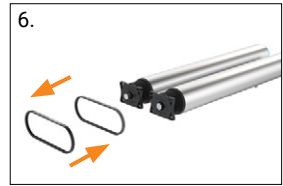

6. Replace the Poly-V belt

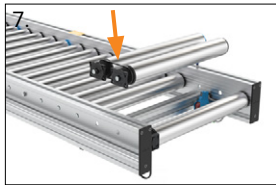

7. Insert the rollers into the mount

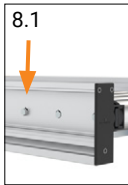

8.1 The spring axis snaps into the mount

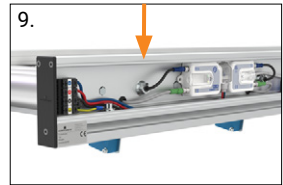
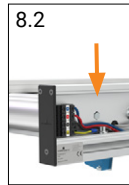

9. Attach the hexagonal nut (and torque support if needed) to the cable outlet (50Nm)



10. Mount the cover profiles



11. Snap in protective elements



7. Components used

7.1 Zone sensor for powered roller conveyor

- for detecting products in the lift station
- for checking if the product is in the right position

	<p>Manufacturer: Wenglor Type: OPT1507 Item number: 278059</p>
---	---

7.2 Light curtain

- prevents start-up of the lift station when a product is above the powered roller conveyor

	<p>Manufacturer: Wenglor Type: P1KL007 Item number: 339318</p>
--	---

7.3 Reflector

	<p>Manufacturer: Wenglor Type: RE18040BA Item number: 333767</p>
---	---

7.4 Inductive sensor

- Sensor for reference run

 A cylindrical inductive sensor with a blue top cap and a threaded body.	<p>Manufacturer: Wenglor Type: I12H022 Item number: 340726</p>
---	---

7.5 Safety switch on the maintenance door (optional)

- instantly switches off the drive

 A red and black safety switch with a lever and two black buttons. The brand name 'EUCHNER' is visible on the red part.	<p>Manufacturer: Euchner Type: 084451 Item number: 174833</p>
--	--

7.6 Motor with absolute encoder

Manufacturer	SEW
Spiroplan gear motor	WA30 DRN80MK4/BE1HR/TFAK8W
Speed [r/min]	1435 / 140
Total ratio [i]	10.25 / finite
Number of teeth numerator / denominator	41/4
Output torque [Nm]	33
Operating factor SEW-FB	1.95
Type IM	M0A / Universal design
Terminal box position [°]	270 (T)
Cable entry	normal
Lubricant / quantity [l]	SEW PG 460 synthetic oil / 0.40
Paint coat	Top coat RAL7031 blue rey
Gearbox	WA30
Hollow shaft	20mm
Execution type	Hollow shaft
Cover	none
Documentation No. A	26865343, 26883392
List of components	202561500
Motor	DRN80MK4/BE1HR/TF/AK8W
Motor power [kW]	0.55
Motor frequency [Hz]	50
Duty cycle S1-S10	S1 Motor voltage [V]
Switching mode	230/400 delta/Y-connection
Rated current [A]	2,25 / 1.29
cos phi	0.75
Circuit diagram	R13 / 680010306
Heat class [°C]/protection class [IP]	155(F) / 54
International Efficiency Class	IE3 Efficiency at 50/75/100
Pn [%]	78.6 / 81.0 / 80.8
CE mark	Yes
Brake	BE1
Manual release	HR = manual release
automatic	reengaging
Manual release position [°]	213
Brake voltage [V] / brake torque [Nm]	400 AC / 5
Brake rectifier	BMK1.5
Brake wiring diagram	B104 / 690050206
Fan guard	Metal fan guard
Motor protection	TF = temperature sensor
PTC encoder	AK8W / Shaft-centered force-fitted attachment via tapered shaft
Electrical interface	asynchronous, serial RS485
Incremental value	2048
Absolute value	Singleturn 16 Bit + Multiturn 16 Bit
Encoder connection	integrated encoder plug connector on the encoder cover with connection cover; without thermal monitoring of motor A1GA
Encoder IS position/cable entry	270 (T) / normal
Encoder characteristic	Supply voltage DC 7-30V

Encoder circuit diagram no.	681810208
Encoder code 1	03AA20AN60AC
Technical data sheet of encoder	63297795
Pin assignment diagram	660850406
Terminal box	Terminal box lower part made of aluminum with threaded hole 2xM25, 1xM16
Documentation No. A	25957066, 26857987, 26864274
First type plate set / position	180°
Weight	19.0 kg

7.7 Converter with profinet card

Manufacturer	SEW
Inverter	MDX61B0011-5A3-4-0T/DEH11B/DFE32B
Part number	08277362
Size	0M
Device version	Technology version
Integrated mains filter	Category C2
Rated mains voltage [V]	3x380-500 +/- 10%
Rated mains current [A]	2.80
Rated mains frequency [Hz]	50-60 +/- 5%
Rated output power [kW]	1.10
Rated output power [HP]	1.50
Apparent output power [kVA]	2.1
Power loss (90;100) [%]	2.8
International Efficiency Class	IE2
Output voltage [V]	3x0-U input
Rated output current [A]	3.10
Output frequency [Hz]	599
Motor load, linear [kW]	1.1
Motor load, square [kW]	1.5
Minimum ambient temperature [°C]	0
Maximum ambient temperature [°C]	+50
IP Protection class	20
Encoder slot	DEH11B, part number 08243107
permissible encoders	Hiperface, sin/cos, TTL
Fieldbus slot	DFE32B, part number 18213456
Ethernet Protocol for	PROFINET IO RT, HTTP, SMLP, DHCP
Option status	options built in
Braking resistor	BW072-005, part number 08260605
Design type	Flat design
Power at 100% cdf [kW]	0.45
Power at 12% cdf [kW]	1.11
Resistance [Ohm]	72 +/-5%
IP rating	IP54
Braking resistor status	enclosed
Number of braking resistors	1
Documentation No. A	24770523, 25899120, 26865645
Weight	3.9 kg

8. EU Declaration of Incorporation

(in accordance with 2006/42/EG from 09.06.2006, Annex IIB, part B for the installation of a partly completed machinery)

We, as the manufacturer of the partly completed machinery, hereby declare under our sole responsibility that for the machine specified below:

- the essential requirements of the harmonized directive 2006/42/EC listed below were applied and complied with
- the specific technical documentation was created in accordance with Annex VII, Part B
- this specific technical documentation will be transmitted in accordance with Annex VII, Part B, in response to a reasoned request, to the national authorities in printed form or electronically (pdf)

Manufacturer: Robotunits GmbH
Dr. Walter Zumtobel Strasse 2
6850 Dornbirn, AUSTRIA

Product:

Harmonized regulation (directive):

2006/42/EC (09/06/2006) Applied and fulfilled essential requirements:

1.1.2., 1.1.3., 1.1.5., 1.3.1., 1.3.2, 1.5.8, 1.5.9, 1.5.13

2014/35/EU Low Voltage Directive

2014/30/EU EMC Directive

Authorized representative for the technical documentation: Robotunits GmbH
Dr. Walter Zumtobel Straße 2
6850 Dornbirn, AUSTRIA

This partly completed machinery must not be put into service until the machine into which this partly completed machinery is to be incorporated has been declared in conformity with the regulations of the Machinery Directive 2006/42/EC.

Signed for and in the name of:

Robotunits GmbH



Christian Beer
Managing Partner

Dornbirn, 29.04.2022

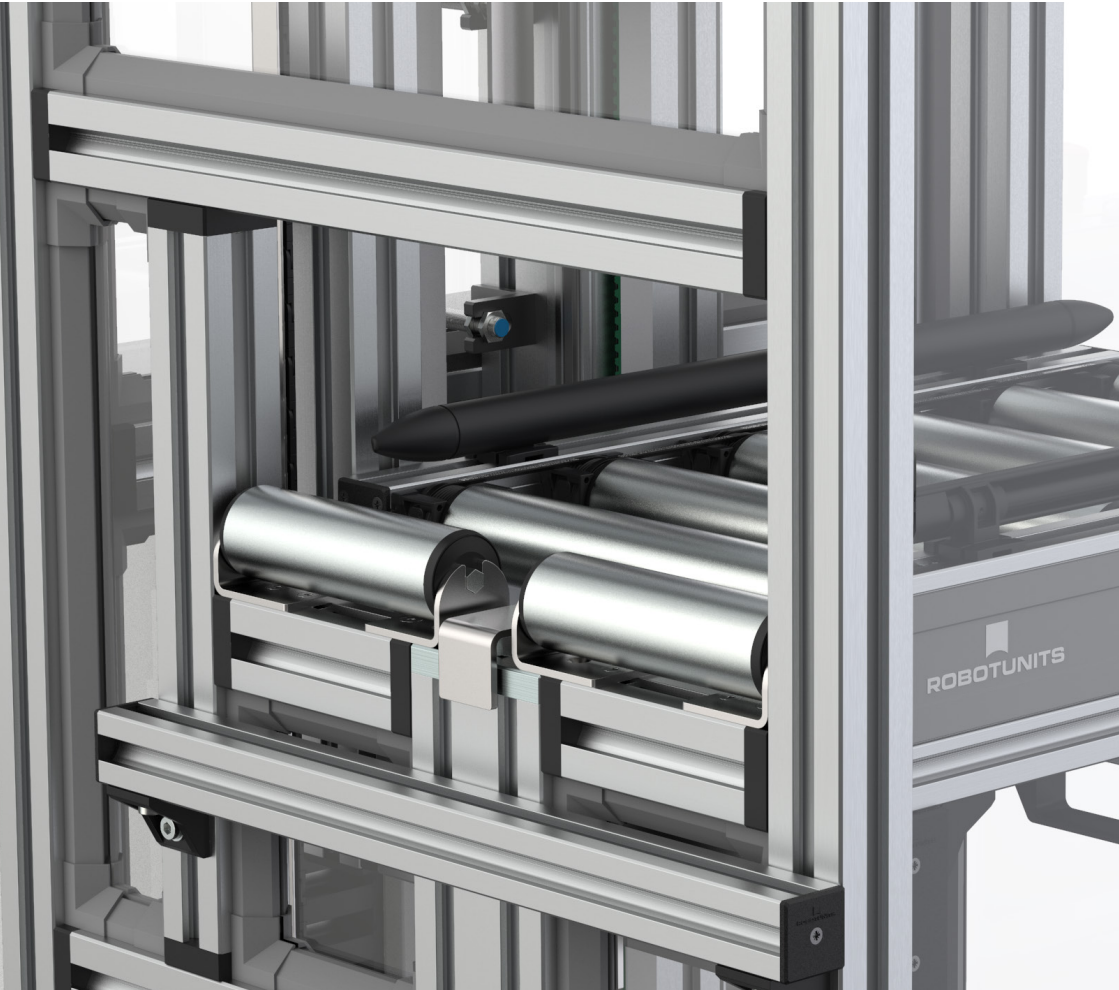

We reserve the right to alter technical specifications at any time.
We assume no liability for typesetting and printing errors.

Austria • Germany • Switzerland • Italy • France • Spain • Czech Republic • USA • Australia

www.robotunits.com